

Thank you for your purchasing the motorcycle, with four stroke and pedal style. Hope you enjoy driving it all the time.

The motorcycle is the most fashionable pedal style and top grade and using for city nowadays. Because it's engine is produced by advanced technical and the parts and components are selected to assemble, with large horsepower, low consuming, low noise, electric ignition, electric starting, frame body with protecting, quick accelerating reaction, actively driving, and superexcellent performance..

The manual contains the necessary instructions and guidance with respect to the operation and maintenance of the motorcycle, keep it at an optima performance. Please you understand if the specification is changed, the parts of drawing or contents in book are different from the fact.

Please you read carefully the book before driving for your safety and making your comfortable.

The capacity of motorcycle can proper adjusted by experienced worker according to different the area, climate and conditions until the best condition, and don't effect on the performance.

Please you note environmentalism.

Contents

1.regulations of safe driving.....1	Way of parking.....21
Way of driving.....2	5.inspecting before driving.....22
Loading.....3	Inspecting and supplying gasoline.....23
2.locations of parts.....4	Inspect braking.....24
3.handling of parts.....5	Inspect braking light.....25
Meters.....6	Inspect turn signal.....25
Indicators.....6	Inspect tire.....26
Main switch.....7	Inspect air cleaner.....28
Starting button switch comp head light.....8	Replace fuel.....28
Changing switch,head light button comp horn.....9	Replace gear oil.....29
Switch comp turn signal.....10	Inspect spark plug.....30
Key,helmet luggage box.....11	Term maintenance program and schedule.....31
Hey comp steering handle.....12	Clean out the battery.....32
Front luggage box.....13	Replace the fuse.....33
Engine starting system.....14	Cleaning way of air cleaner.....34
Electric starting.....14	Adjusting the carburetor and the choke.....35
Kick starting.....15	7.specification table.....36
4.natural way of driving.....16	8.electric circuit drawing.....37
Correctly driving.....18	

1.SAFE DRIVING

Safe driving main point is natural and relaxing mood and wearing comfortable dress, Pay attention to driving with obeying ruler of traffic, don't worry and relax the mood.

CAUTION:

the drivers don't wear loose or longed clothes, avoid to happen damage.

- the skin of body don't touch with the exhaust pipe after flameout the motorcycle within 10 minutes, for the temperature of is very high during the driving.

Clothes:

- catch hold up the handle bar
- when driving wear



WAY OF DRIVING

- keep your only natural posture to actively driving the motorcycle.

- the position effect on the rider' s safe, please seat at the center of double seat, if driver seat at the end of double seat and make front wheel reduce weight and the handle bar will swing, in a word, this happen to damage

- when driving at the swerve, please keep the body to inner side, if else happen to damage.

- please pay attention to driving on the no-smooth road.

Loading

- the handle bar can feel the change of weight between the loading and no-loading. So please driving caution. When the loading overtaking, the handle bar shake easily, please avoid overtaking driving.



NOTE:

- Don't place the clothe under the seat(outer luggage),if else, make the fuel system choked and the engine ill.
- Don't place the clothe between the outer cover of frame and the engine if else happen to damage the engine.
- Don't replace the goods at the outer luggage which is pointed, avoid to damage the outer of frame body.

2.LOCATIONS OF PARTS:





Rear Light Assy

Handle, Baggage Rack

Rod comp front brake stop

Oil ruler

Exhaust Muffler

Front Hydraulic Brake System

3.INSTRUCTIONS FOR FHE MOTORCYCLE

■ Speedometer and indicator

(1)Mileage recorder

It display the total distance covered by the vehicle(km)

(2)speed indicator

The standard of speed:km/h

(3)Pilot of headlight

Pilot of headlight is switched and indicate the pilot light.

(4)Turn signal indicator

The signal is switched and the indicator is light.

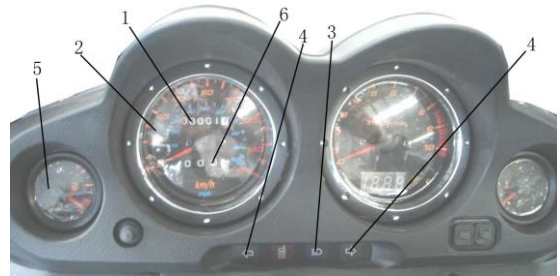

(5)fuel meter

The fuel indicator shows the fuel capacity remaining in the fuel tank(when the main switch is ON,the meter indicates correctly, when the position of OFF,the meter indicates correct) when the needle is at the red zone,it indicated the fuel is 1.5L,and please supply the fuel 90# in time.

(6)shortage distance meter

It is use for shortage distance and can indicate “0”.

■ Main switch

- OFF**
- Electrical source is cut off and the engine stopped.
 - The key can be taken down.

- ON**
- Electrical source is on and started.
 - The key can not taken down when driving.

- LOCK**
- The steering handle pipe is locked and avoid theft.
 - The key can be taken down.

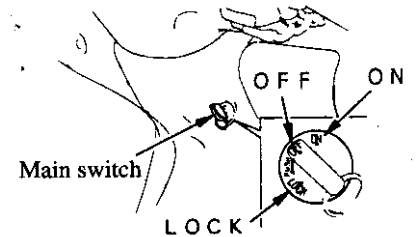

NOTE:

- When parking the motorcyle, lock the turning bar and take down the key, avoid to theft the motorcyle.

■ Starting button:

When use the electric starting, please draw the rod comp front brake stop, or step the pedal comp rear brake, until the electrical source is touched on.



■ Switch comp headlight

■ Headlight OFF:

OFF

• Headlight, sidelights, speedometer light are shut off.

.

• sidelights, speedometer light are switched on. (the engine don't start and the lights are shutoff)

.

• Headlight, speedometer light are switched on (the engine don't start and the lights are shut off)



■ HEAD LIGHT, CHANGE SWITCH OVERTAKE SIGNAL SWITCH

HI  when the pilot is switched, using the HI

LO  When driving at the city and front vehicle, using the LO, avoid to effect on the sight of front

PASSIN  Overtaking warning light at the position of LO, put down it and headlight is switched on, indicates front vehicle.



■ HORN BUTTON:

When the main switch is ON, put down the button of horn, and the horn tweets.



■ Switch comp turn signal:

When swerve or change roadway, please turn signal. When changing switch, the turn signal can spark or shut off.

NOTE:

- Please return the turn signal after using because it can't relax, if else effect or other people's safe.

L :Using it at the turning left.

R :Using it at the turning right.



■ KEY OF HEMET

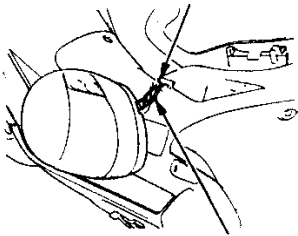

Way of using

- (1) Open lock comp seat and put up the seat.
- (2) Make the key into hook.
- (3) Push down seat and the seat auto can be locked.

Way of take down

- The way of using is the same to above.

NOTE:

- When driving, don't make the key leave the helmet lock and avoid damage paint parts.

■ LUGGAGE BOX:

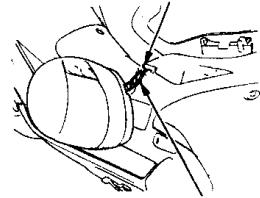

Luggage box lies under the seat.

Way of opening seat is the same as above.

NOTE:

- The max weight of loading: not exceed 10kg.
- check the seat is locked.
- Don't place the low-heat-resistant goods, foods and combustibile goods into the luggage box, because of the high temperature of engine.
- Don't place the expensive goods into the luggage.
- Don't make the water into the luggage box, when cleaning the motorcycle.

■ FRONT LUGGAGE BOX

Way of opening

Insert the key and turn it right, the front luggage can push up.

Way of closing:

Insert the key and turn it right, close the cover of luggage box. And then turn left and take down.

NOTE:

- The max weight of loading if front luggage box: not exceed 1.5kg.
- Don't place the expensive goods into box.
- Please note the expensive goods placed, because water will into box when cleaning the motorcycle.



■ FRONT LUGGAGE BOX

Way of opening:

Insert the key and turn it right, the front luggage can push up.

Way of closing:

Insert the key and turn it right, close the cover of luggage box. And then turn left and take down.

NOTE:

- The max weight of loading in front luggage box not exceed 1.5Kg.
- Don't place the expensive goods into box.
- Please note the expensive goods placed, because water will into box when cleaning the motorcycle



■ Way of starting for engine:

- (1) Check the gasoline, fuel and battery starting.
- (2) Stand the main stand when starting engine, and make the rear wheel nearly room.
- (3) Turn the key of bank to “ON”.

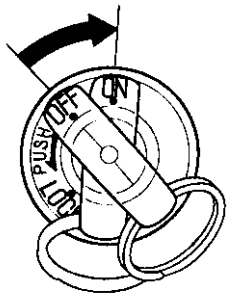

- (4) Adopt the electric/kick starting. If adopt electric starting, must catch hold of front brake bar or step rear brake pedal.

- (5) When driving in winter, turn the key of bank to “OFF”, kick starting about 5 times and make into gasoline, then touché with the electric road, with accelerating and warm up the engine about 2- minutes. All are OK.

NOTE:

- Please using it according to above(5),when the gasoline don't reach the standard of 90# or using it long time, and starting it again.
- when using the new motorcycle first, kick starting it and can longed the usage life.

- (6)Because the motorcycle designed advanced electric starting valve, can start it with kick/electric starting.

(ELECTRIC STARTING)



NOTE:

After starting the engine the hand leave the button and don't touch with it when driving; catch hold of the front brake bar or step the rear brake pedal, the braking light is switched, but pushing time is not exceed seconds, and the time share is about 10 seconds. The above times is not exceed 4times.



NOTE:

Return the starting arm after starting engine, if else will effect on safe of driving .

4. WAY OF NATURAL DRIVING

1 Spring the main stand firstly

- Push ahead and the main stand will auto spring.



NOTE:

- Don't freely add oil and make the engine high speed before the engine don't driving.

- Ride the motorcycle from left side and seat well, the left foot touch with room and avoid to rave.



NOTE:

- Keep the front and rear brake the position of braking before driving.

2 Loose rod of rear brake

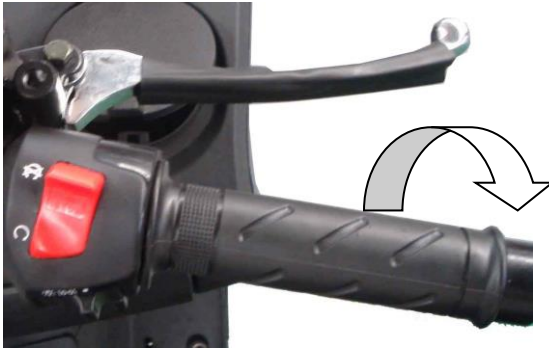

NOTE:

- Don't add freely gasoline to the turning bar after loosening the rod of rear braking, avoid to happen dangerous

3 Turns the grip of throttle slowly and the motorcycle moves slowly.



NOTE:

- Don't turn the grip of throttle quickly and avoid the motorcycle

4 Correctly driving

Before driving the motorcycle, please open turn signal and confirm the rear safe.



Adjusting of speed is controlled by the grip of throttle.

Return inner

The speed will become faster, so please accelerate slowly.

The grip shall return to accelerate and the power become high when begin ning to start or climbing.

Return origin position

The speed become slowly.

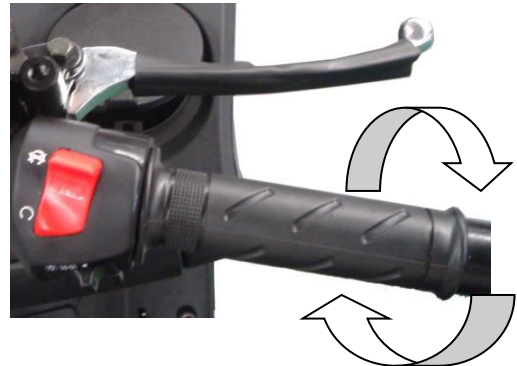

■ The first period of new motorcycle running will effect on the usage of engine.

• please keep the speed less 60km/h in the first period of 1500km, details as followings;

Driving mileage	0-300	300-500	500-1000	1000-1500
Speed(km/h)	25-30	35-40	45-50	55-60

- Avoid accelerating quickly and overtaking loading.
- Replace the oil of crankcase and gear oil the warm condition the period of meshing.
- Avoid to driving long time by the full throttle and notice to freely change speed, when the distance of driving are over 1500km.

■ Using the front&rear braking stopping when parking

- Parking the motorcycle after returning the grip of throttle to origin position.
- Start to parking slowly, and then step and saw urgently the vehicle.

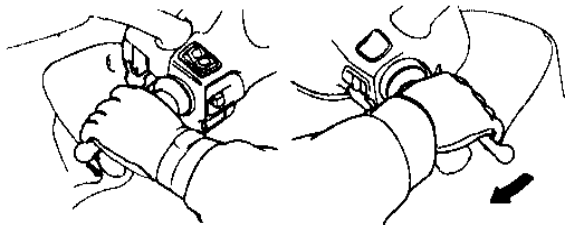

NOTE:

- Don't stop the motorcycle by the single wheel. if else happen to accident.

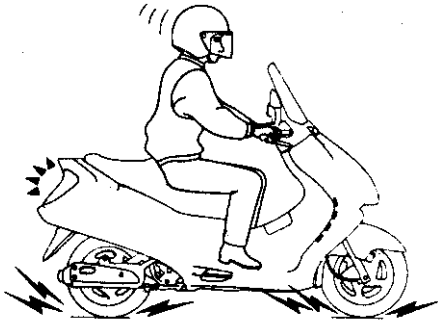

is one of

- please decelerate to drive because of longed the distance and the difference of road between the sung and wet days.
- Return the throttle grip to “OFF” and proper discontinuity braking when downgrade.



■ Notice driving the wet day.

■ Way of parking:

1 Near the parking place:

- Open the turn signal ahead of time and notice the rear and side of vehicle and stop it slowly.
- Return the grip of throttle to origin position and brake the vehicle, at this time the rear braking light is switched and warn the rear vehicle.

NOTICE: If the vehicle inclines excessively which parking which make the idle speed instability.

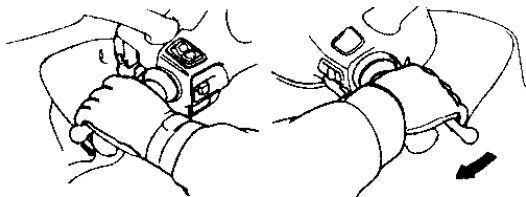

2 The vehicle complete stop

Return the turn signal to origin position and switch to “OFF”

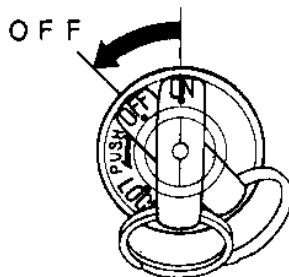

NOTICE:

- when driving if cut off main switch and take out key, the electric system don't work, and happen to accident easily. So please handle it when parkin.

3 When parking

Stand the left side of motorcycle in the smooth land and support main stand of motorcycle

- Support the main stand in the little traffic and smooth land, if else happen to accident easily.
- The left hand catches hold of handle bar and the right handle draws side rod under seat. The right feet step main stand and the right hand draw it rear

4 Lock the handle bar and take out the key in order to avoid theft when parking.

(please reference the page 12).

5.Inspection before driving

■ Inspection before driving

Please have a habit of checking vehicle before driving.

Must check the vehicle before driving in order to avoid happening accident.

If you find the trouble of vehicle, please contact with the seller or service place.

■ CHECK AND SUPPLY OIL

1.Support the frame body and take out the ruler of oil to clean.

2.straight insert the ruler of oil.

3.take out the ruler of oil and check the rest oil. If the level of oil reach at the under limit, please supply the oil until the upper linmit.

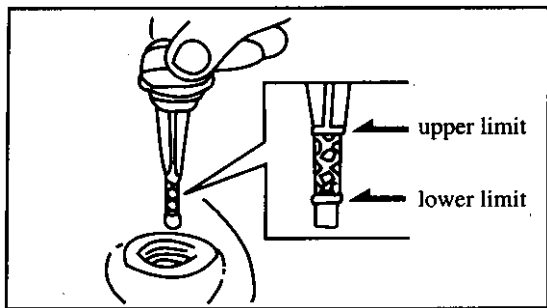

■ APPOINTED ESPECIAL OIL

Four stroke especial oil:SAE10w-30(SIGMA)

NOTICE:

1. Don't use the counterfeit oil, if else happen easily accident.
2. please use and supply the oil according to state, in order to assure the safe and natural driving.

1 CHECK AND SUPPLY GASOLINE

- Supply the oil when the needle reach the red zone, at this time the rest gasoline is about 1.5L.
- Supply the gasoline of 90#in time.

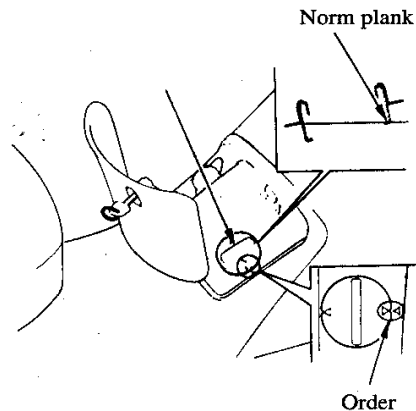

2 Antifreeze

- You'd better use cooling **antifreeze**
- If the temperature beyond 20°C, please check antifreeze in every 300km

• Check antifreeze

• Check ancillary water tank

1. Raise up main bracket first, keep the key turn in clockwise, then the cap be opened.
2. Secondly, open the cap of ancillary water tank and check the antifreeze, usually antifreeze in the tank should achieve 2/3.
3. The antifreeze cannot be saw, you'd better immit antifreeze from sprue to make sure the cooling effect of engine

Sprue



• Check sprue

1. Keep the key turn in clockwise, the seat can be opened
2. Take off the screw on the battery cover which under the seat with crossed-screwdriver, then take away the battery cover
3. Turn the cap in anticlockwise, then the cap can be opened. Infuse the antifreeze to mouth of cap and air will be removed from the water tank.



Sprue cap

NOTE:

1. To avoid scald, please don't open the cap before the engine be cooled

3 CHECK BRAKING

《WINDAGE OF BRAKING ROD》

The braking rod must have proper windage. And it's active is work naturally.

Range of measuring windage:1-2cm



<CHECKING BRAKING OIL>

- 1.Place the handle bar correctly, check the braking oil in right fuel tank, and keep it the position between the up per and under limit.
- 2.check the meshing of rubber when the braking reaches the under limit.
- 3.Please maintain it to the service place when the rubber worn but not exceed the stated ruler.
- 4.recommend the braking oil:DOT3

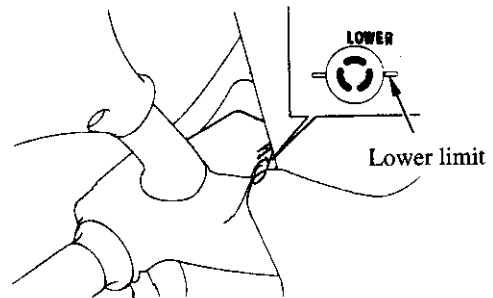

4 Inspection of braking light

- Turn the main switch to : “ON”.
- Brake the front&rear braking and confirm the light is switched.
- Check the braking light is broken and untidy.



- Turn the main switch to “ON”.
- Handle the switch of turn signal and confirm the front rear, left and right turn signal, turn signal indicator are switched.

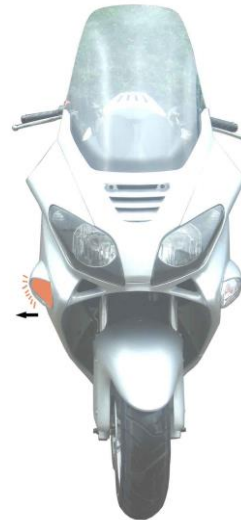

5 Inspection of turn signal

6 Inspection of wheel

- Check the pressure of tire

Natural pressure

Front wheel tire.....196Kpa

Rear wheel tire.....211Kpa

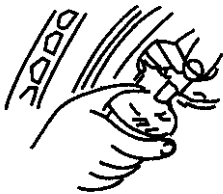

(pressure of tire)

- Check and clean out metal and crush pieces in the tire trough
- Please change into new tire, if the crush or the depth of trough reach the limit.

(please reference the drawing)

(metal, crush piece and other impurity)



(Indication of meshing limit)



- **Please maintain the vehicle, assure to comfortable driving.**

(please reference page31)

- **please check termly the vehicle when don't use it long time.**

- **The first inspection:**

Please accept inspection and maintenance after purchasing a month or driving 300km.

■ CHECK THE SPLINE COLLAR OF REAR TIRE AND FRONT&REAR HANGER SET

- When check the spline, support the vehicle by the center stand. Push the side of rear tire and look if the rear collar and the ring of rear fork loosen.
- Check carefully whether the location set of rear hanger system is stability.

■ CHECK AIR CLEANER

- The air cleaner is made in paper, and check and clean it every 200km. After clean it, add equality a little oil.
- Change into termly new air cleaner 5000km. Way of changing reference the page38.

NOTICE:

- Please replace and clean it under ways.
- Drive it in the wet days.
- Drive it in the dust roadway

■ CHANGE OIL

Replace the oil firstly 300km, after every 1000km. check the oil capacity every 500km and supply the oil in time until the limit. The capacity of oil:0.9L, and the oil capacity of normal changing :0.75L.

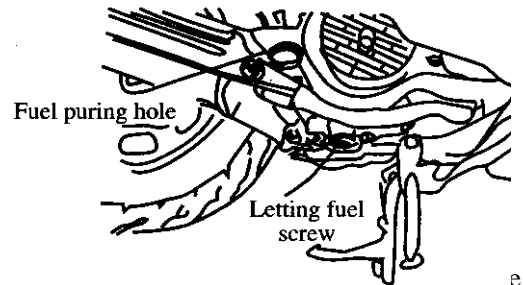

driving the crush, short distance and cold zone place. when get down the screw of letting oil clean the filter and fit it.

■ Change gear oil

<term of changing>

Replace into the 10#or GY gear oil firstly 300km and after every half a year or 3000km.

CAPACITY OF GEAR OIL

- Full capacity:0.11L

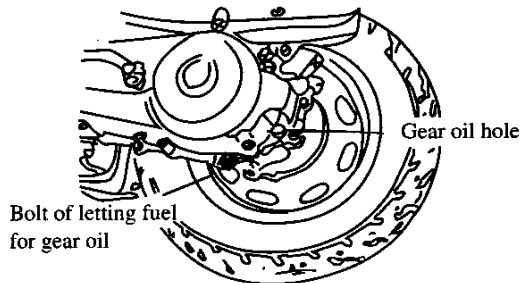

<way of changing>

- 1.Support the vehicle in the smooth land.
- 2.Get down the screw of oil.
- 3.If change oil the warm of engine, the rest oil will pour out gear box.
- 4.Clean the screw of letting oil and lock it.
- 5.Pure the oil into the gear box from the hole.
- 6.Lock the screw and avoid leakage.

NOTICE:

- Please replace oil usually as following:
- Driving the wet days usually.
- Driving long time.(long distance)
- Driving at the loading.

■ CHECK SPARK PLUG

The untidily of spark plug electrode and exceed windage effect on it's work.

<way of cleaning>

The best way is using cleaner of spark plug to clean.

If have not cleaner, please use the needle brush.

<ADJUSTING>

- Windage of side pole:0.6-7mm
(reference drawing)

<Appointed spark plug>

G7HSA(NGK)\

U22FS-U(ND)

NOTE:Don't use the spark plug which isn't appointed.

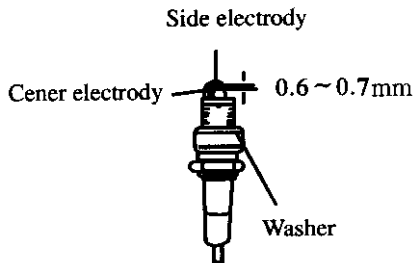

NOTICE:

- Notice not to scald body because of high temperature of engine after stopping it.
- Twist into the spark plug with hands and wrench

TERMLY MAINTAIN PROJECT AND SCHEDULE:

Assure to driving safely, maintain the performance, longed the usage and reduce the pollute, please check and maintain it termly.

I:Checking, cleaning, lubricating, adjusting, or replacing A:adjustment C:cleaning R:replacing T:lock

ITEMS	DRIVING DISIANCE(km)													Check Ing before Driving
	300	1000	2000	3000	4000	5000	6000	7000	8000	9000	10000	11000	12000	
Engine oil	R	R	R	R	R	R	R	R	R	R	R	R	R	I
Oil filter web	C		C		C		C		C		C		C	
Gear oil	R		R		R		R		R		R		R	
Spark plug	Clean and replace it every 1000km													
Windage of valve in 0.1.2.out:(cold system)		A			A				A				A	
Cam chain		A			A				A				A	
Carburetor			I		I		I		I		I		I	
Air cleaner	Clean every 2000km and replace every 5000													
Electrolyte of battery		I	I	I	I	I	I	I	I	I	I	I	I	I
Fuel filter web	Clean and replace it every 1000km													
Braking system		I	I	I	I	I	I	I	I	I	I	I	I	I
Drive belt					I				I				I	
Parts screw and nut	T			T			T			T			T	
Waste air deepness		Frequently check, adjust avoid pollute.												
<ul style="list-style-type: none"> • The above items will change according to deferent from the kind of vehicle. • Use it as compare with the schedule if overtake the mileages. • Please clean and replace the air cleaner usually driving the dust area. 														

■ CHECK THE ELECTROLYTE OF BATTERY

1 The vehicle adopt no-supplying water or supplying electrolyte battery.

Don't need to check and supply the no-supplying water battery.

NOTICE:

- Don't get down the seal electrolyte battery.
- when don't use the vehicle, please get down the battery and put p the cold and good air place, because it automatic discharge and reduce the power.
- Don't use the vehicle long time, please get down the cathode.

The line of liquid keep the level between the upper and the under limit, when use the supplying electrolyte battery. And supply proper the distilled water sometimes and keep up the good air condition.

2 BATTERY HEAD

Firstly get down the three screws and battery cover when cleaning the battery head.

- Get down and clean the battery when the battery head is rotten.
- After cleaning it, please wipe a group of butter or Vaseline and fit it.

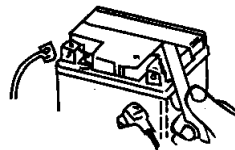

NOTICE:

- When getting down, shut off the electric source and get down the cathode. When fitting on , firstly fit on the positive pole.
- Lock the screw of battery head when it loosens.

■ Replace the fuse

Shut off the main switch and check whether the fuse is scaled or not

Replace the fuse according to the power appointed.

- Please find the clause of scaling and replace it.
- Get down the three screw and open cover, the fuse lie in the fuse box side of battery.
- Open the fuse box and take out the fuse, draw the guide cable of the fuse.

The specification of fuse:7A



Wire harness assy



Fuse clip



Insert
Fixxing

- Change the electric goods(Light,speedometer) according to the specification good parts appointed.
- If use the disqualification parts, the fuse is scaled easily and the loading of battery will lose it's balance.
- When cleaning the vehicle, avoid using water to clean.

NOTICE:

- When getting down, don't expand the ring too large.
- When fixing, please confirm whether the ring head loosens or not. It's loosening is the clause of troubles, and notice this.
- Don't use the exceed power of fuse, if else happen to damage.

■ Way of cleaning the air cleaner

Dust is the one of the cause of reducing the horsepower.

<way of getting down>

1. Get down the five locked screws in the left rear cover and rear cover, and then get down the seven locked screws.

2. Get down the cover&air cleaner

3. Get down the two located screw of air cleaner.

4. Replace the seal of air cleaner.

<way of fixing>

- Operate it according to above contrary ways.

NOTICE:

- If the air cleaner is not complete fit, the dust will enter into cylinder and make the horsepower down and usage of engine.
- Don't soaked air cleaner when cleaning the vehicle, if else make the engine ill.

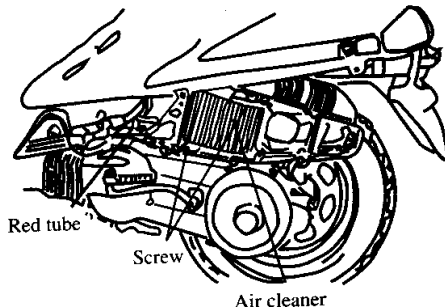
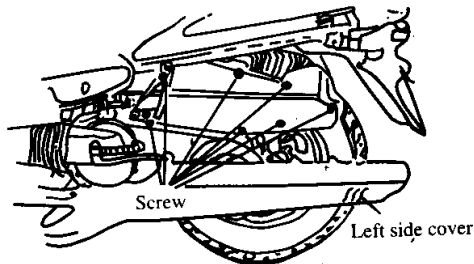

NOTE: please let out the oil in red tube every driving 1000km

■ ADJUST THE CARBURETOR AND CHOKE
Function of stability contrary can assure to the

performance of the engine. The carburetor is adjusted the best condition in the manufacture and don't change the condition. Now you shall adjust the two projects as followings:adjusting of choke and idle speed.

(a)Adjusting of choke

1.Check whether the choke and throttle work well the conditions of full opening and closing for choke or not.

2.Check the free distance in the position of drawing turn bar, and the free distance:2-6mm. if adjust the distance, please loosen nut(1)and adjustor(2).

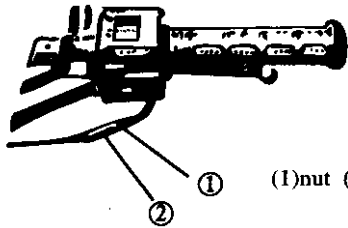

(1)nut (2)adjustor

(b)Adjust the idle speed

1.Warm the engine many minutes and start it.

2.Twist the adjusting nut of oil, and slowly drop it about $3\frac{1}{8}$ circle. Lock it the max place and adjust lightly the limited screw until reach at the requirement of idle speed.

7.THE SPECIFICATION SCHEDULE:

Over size:length×width×high	2070×735×1410	The min consume L/100 km	≤2.9
Wheel base: mm	1450	Braking distance m	≤7(30km/h)
Dead mass kg	130	Climb performance (°)	≥10
Capacity of fuel tank kg	165	Engine model	172MM
Oil capacity of crankcase L	12	Style	Single cylinder,forced water four stoke
Trademark of fuel L	1. 1	Stroke×bore	72×60
燃油牌号	RQ-90	Capacity cm ³	244
Trademark of lubricant	Four stoke especial oil SAE10W-30(SIGMA)	Compression ratio	10.0: 1
The max speed km/h	≥110	The max power kw/r/min	11.0(7000)
		The max torque Nm/r/min	17.6(5500)

Start	Electric	Battery	12V9Ah
Ignition system	CDI	Head light	12V35W/35W
Spark plug	DPRTEA-9	Tail light/braking light	12V8W/20W
Lubricant system	Force lubricant	License light	12V5W
Clutch	Dry-auto acentric	Speedometer indicator	12V1.7W
Change speed system	Belt auto no-grade shift	Fuse	15A
Decelerate	I, 2.2 6.6	horn	12V3A105dB(A)
The specification of tire	Front tire	130/60-13	
	Rear tire	130/60-13	
Pressing of tire:	Ront tire	196	
	Rear tire	221	

8.ELECTRIC PRINCIPAL DRAWING

0	1	2	3	4	5	6	7	8	9	10	11	12	13	14	15	16	17	18	19	20	21	22	23	24	25	26	27	28	29	30	31	32	33	34	35	36	37	38	39	40	41	42	43	44	45	46	47	48	49	50	51	52	53	54	55	56	57	58	59	60	61	62	63	64	65	66	67	68	69	70	71	72	73	74	75	76	77	78	79	80	81	82	83	84	85	86	87	88	89	90	91	92	93	94	95	96	97	98	99	100
0	1	2	3	4	5	6	7	8	9	10	11	12	13	14	15	16	17	18	19	20	21	22	23	24	25	26	27	28	29	30	31	32	33	34	35	36	37	38	39	40	41	42	43	44	45	46	47	48	49	50	51	52	53	54	55	56	57	58	59	60	61	62	63	64	65	66	67	68	69	70	71	72	73	74	75	76	77	78	79	80	81	82	83	84	85	86	87	88	89	90	91	92	93	94	95	96	97	98	99	100

0	1	2	3	4	5	6	7	8	9	10	11	12	13	14	15	16	17	18	19	20	21	22	23	24	25	26	27	28	29	30	31	32	33	34	35	36	37	38	39	40	41	42	43	44	45	46	47	48	49	50	51	52	53	54	55	56	57	58	59	60	61	62	63	64	65	66	67	68	69	70	71	72	73	74	75	76	77	78	79	80	81	82	83	84	85	86	87	88	89	90	91	92	93	94	95	96	97	98	99	100
0	1	2	3	4	5	6	7	8	9	10	11	12	13	14	15	16	17	18	19	20	21	22	23	24	25	26	27	28	29	30	31	32	33	34	35	36	37	38	39	40	41	42	43	44	45	46	47	48	49	50	51	52	53	54	55	56	57	58	59	60	61	62	63	64	65	66	67	68	69	70	71	72	73	74	75	76	77	78	79	80	81	82	83	84	85	86	87	88	89	90	91	92	93	94	95	96	97	98	99	100

0	1	2	3	4	5	6	7	8	9	10	11	12	13	14	15	16	17	18	19	20	21	22	23	24	25	26	27	28	29	30	31	32	33	34	35	36	37	38	39	40	41	42	43	44	45	46	47	48	49	50	51	52	53	54	55	56	57	58	59	60	61	62	63	64	65	66	67	68	69	70	71	72	73	74	75	76	77	78	79	80	81	82	83	84	85	86	87	88	89	90	91	92	93	94	95	96	97	98	99	100
0	1	2	3	4	5	6	7	8	9	10	11	12	13	14	15	16	17	18	19	20	21	22	23	24	25	26	27	28	29	30	31	32	33	34	35	36	37	38	39	40	41	42	43	44	45	46	47	48	49	50	51	52	53	54	55	56	57	58	59	60	61	62	63	64	65	66	67	68	69	70	71	72	73	74	75	76	77	78	79	80	81	82	83	84	85	86	87	88	89	90	91	92	93	94	95	96	97	98	99	100

0	1	2	3	4	5	6	7	8	9	10	11	12	13	14	15	16	17	18	19	20	21	22	23	24	25	26	27	28	29	30	31	32	33	34	35	36	37	38	39	40	41	42	43	44	45	46	47	48	49	50	51	52	53	54	55	56	57	58	59	60	61	62	63	64	65	66	67	68	69	70	71	72	73	74	75	76	77	78	79	80	81	82	83	84	85	86	87	88	89	90	91	92	93	94	95	96	97	98	99	100
0	1	2	3	4	5	6	7	8	9	10	11	12	13	14	15	16	17	18	19	20	21	22	23	24	25	26	27	28	29	30	31	32	33	34	35	36	37	38	39	40	41	42	43	44	45	46	47	48	49	50	51	52	53	54	55	56	57	58	59	60	61	62	63	64	65	66	67	68	69	70	71	72	73	74	75	76	77	78	79	80	81	82	83	84	85	86	87	88	89	90	91	92	93	94	95	96	97	98	99	100

